

0	1	2	3	4	5	6	7	8	9
---	---	---	---	---	---	---	---	---	---

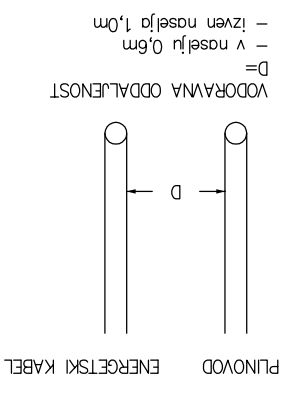
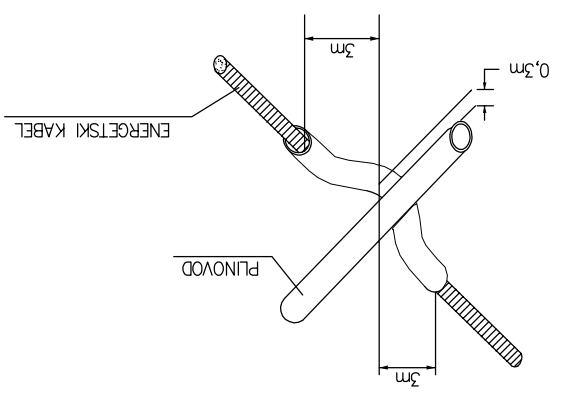
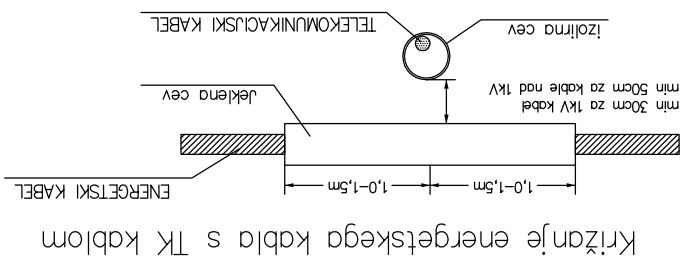
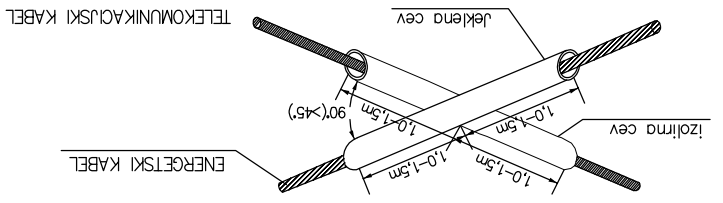
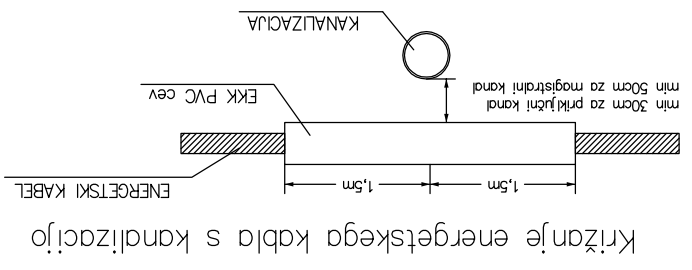
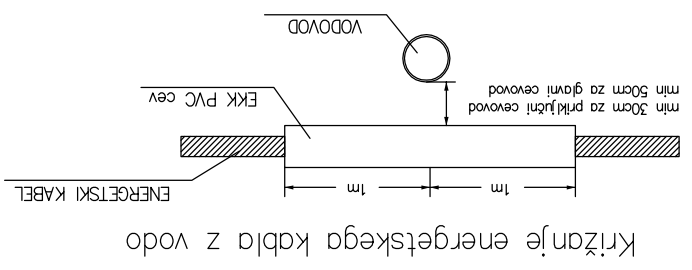
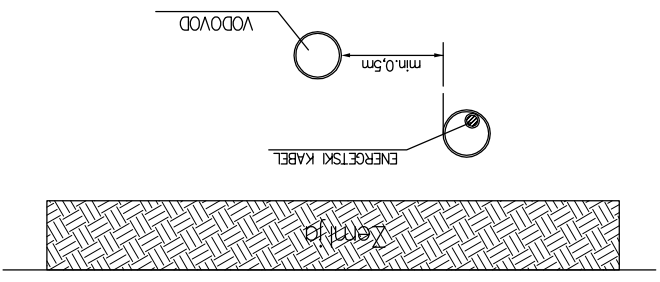

Križanje energetskega kabla s plinovodom

Križanje energetskega kabla z vodo

Križanje energetskega kabla s kanalizacijo

Križanje energetskega kabla s TK kablom

<b>ERDADO d.o.o.</b> U.I. Vena Pilona 29, 5270 Ajdovščina Projektiranje, meritve, nadzor		Investitor: Občina Ajdovščina Cesta 5.maja 6a, 5270 Ajdovščina		Nadt: ELEKTRIČNE INSTALACIJE Močnostne instalacije		Datum: NOVEMBER 2015		Št. projekta: 20-2015		Št. oddatek: 159/10-15		Št. risbe: IZS 1958		Št. strani: 11	
Objekt: PARKIRIŠČE ZA STARIM MLINOM V AJDOVŠČINI		Projekt: PARIKAZ KRIŽANJU VODOV		Sodelavec: Domen Furlan, d.l.e.		mag. Jana Hladnik Tratnik, u.d.i.a. David Furlan, el.teh.		ZAPS-1481 A E-9035		Projekta dokumentacija: PCD					

VODORAVNA ODDALJENOST  
 = v naselju 0,6m  
 = izven naselja 1,0m